

Varenummer: 0108059
 Beskrivelse: Seeger låsering JK 42 DIN 984

Mål

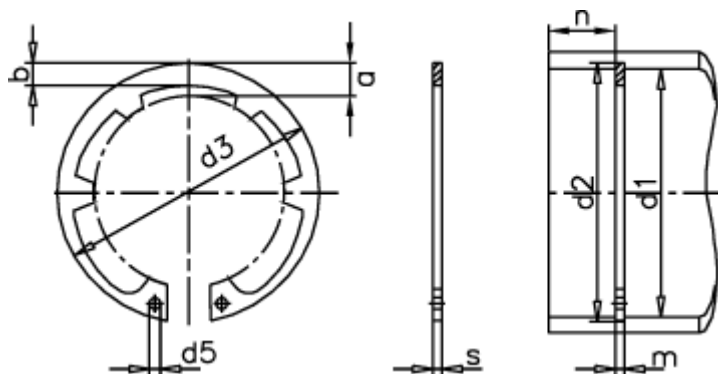

a max	= 7.2	d5 min	= 2.5	s	= 1.75
AN mm ²	= 170.0	FN kN	= 28.4	t	= 1.25
Antal takker	= 6	FRg kN	= 8.4	Tang	= ZGJ-3
b	= 4.1	FR kN	= 44.7	tol	= -0.06
Betegnelse	= JK 42	g	= 2.0	tol	= +0,90-0,39
d1	= 42	K kN-mm	= 80.9	tol	= +0,25
d2	= 44.5	m min	= 1.85	vægt kg/1000	= 6.00
d3	= 45.5	Nominal træk	= 3.8		